



SMART^{TEC}
2,5 kV Insulation / Continuity
MI 3121H
Instruction manual
Version 1.2, Code no.: 20 751 674

Distributor:

Manufacturer:

METREL d.d.
Ljubljanska cesta 77
1354 Horjul
Slovenia
web site: <http://www.metrel.si>
e-mail: metrel@metrel.si



Mark on your equipment certifies that this equipment meets the requirements of the EU (European Union) concerning safety and electromagnetic compatibility regulations

© 2010 METREL

The trade names Metrel, Smartec, Eurotest, Autosequence are trademarks registered or pending in Europe and other countries.

No part of this publication may be reproduced or utilized in any form or by any means without permission in writing from METREL.

1	Preface	5
2	Safety and operational considerations	6
2.1	Warnings and notes.....	6
2.2	Battery and charging	8
2.2.1	New battery cells or cells unused for a longer period	9
2.2.2	Auto Power Off	9
2.3	Standards applied.....	10
3	Instrument description	11
3.1	Front panel	11
3.2	Connector panel	12
3.3	Back panel.....	13
3.4	Display organization	14
3.4.1	Function field	14
3.4.2	Result fields.....	14
3.4.3	Message field	15
3.4.4	Auxiliary monitor.....	15
3.4.5	Battery indication.....	16
3.4.6	Other messages	16
3.4.7	Backlight.....	16
3.5	Instrument set and accessories	17
3.5.1	Standard set.....	17
3.5.2	Optional accessories	17
4	Instrument operation	18
4.1	Function selection.....	18
4.2	Settings	19
4.2.1	Initial settings.....	19
4.2.2	Date and time	20
5	Measurements	21
5.1	Insulation resistance.....	21
5.1.1	Insulation resistance measuring procedure	21
5.1.2	The DAR and PI diagnostic	23
5.1.3	Guard terminal.....	24
5.2	Resistance of earth connection and equipotential bonding	26
5.2.1	RLOW, 200 mA resistance measurement	26
5.2.2	Continuous 7 mA resistance measurement CONT.....	27
5.2.3	Compensation of test leads resistance.....	29
5.3	Voltage and frequency.....	30
6	Data handling	32
6.1	Memory organization	32
6.2	Data structure	32
6.3	Storing test results.....	33
6.4	Recalling test results	33
6.5	Clear / recall options.....	34
6.5.1	Clearing complete memory content.....	34
6.5.2	Clearing individual results at selected location	35
6.6	Communication.....	36
7	Maintenance	37
7.1	Fuse replacement.....	37
7.2	Cleaning	37

7.3	Periodic calibration	37
7.4	Service	37
8	Technical specifications	38
8.1	Insulation resistance	38
8.2	Continuity	39
8.2.1	Resistance RLOW	39
8.2.2	Resistance CONT	39
8.3	Voltage, frequency.....	39
8.3.1	Voltage	39
8.3.2	Frequency	39
8.4	General data.....	40
9	Appendix A - Accessories for specific measurements	41

1 Preface

Congratulations on your purchase of the instrument and its accessories from METREL. The instrument was designed on basis of rich experience, acquired through many years of dealing with insulation and resistance test equipment.

The multifunctional hand-held insulation tester Smartec 2,5 kV Insulation / Continuity is intended in general for the following tests and measurements:

- True r.m.s. voltage and frequency,
- Insulation resistance with high d.c. test voltage up to 2,5kV,
- Resistance to earth connection and equipotential bonding plus continuous resistance measurement.

The custom designed display with backlight offers easy reading of results, indications, and measurement parameters. The operation of the unit is clear and simple – the operator does not need any special training (except reading this instruction manual) to operate the instrument.

In order for operator to be familiar enough with performing measurements in general and in typical applications it is advisable to read Metrel handbook *Guide for testing and verification of low voltage installations*.

The instrument is equipped with all necessary accessories for comfortable testing.

2 Safety and operational considerations

2.1 Warnings and notes

In order to reach high level of operator's safety while carrying out various tests and measurements using Smartec 2,5 kV Insulation / Continuity test equipment, as well as to keep the equipment undamaged, it is necessary to consider the following general warnings:

- ❑  **Warning on the instrument means »Read the Instruction manual with special care to safety operation«. The symbol requires an action!**
- ❑ **If the test equipment is used in a manner that is not specified in this user manual, the protection provided by the equipment might be impaired!**
- ❑ **Read this user manual carefully, otherwise use of the instrument may be dangerous for the operator, for the instrument or for the equipment under test!**
- ❑ **Do not use the instrument and accessories if any damage is noticed!**
- ❑ **In case a fuse has blown follow the instructions in this manual to replace it!**
- ❑ **Consider all generally known precautions in order to avoid risk of electric shock while dealing with hazardous voltages!**
- ❑ **Only a competent authorized person is allowed to carry out service intervention or adjustment and calibration procedure!**
- ❑ **Use only standard or optional test accessories supplied by your distributor!**
- ❑ **Consider that older and some of new optional test accessories compatible with this instrument meet overvoltage category CAT III / 300 V! It means that maximum allowed voltage between test terminals and ground is 300 V!**
- ❑ **Instrument contains rechargeable NiCd or NiMh battery cells. The cells should only be replaced with the same type as defined on the battery placement label or in this manual. Do not use standard alkaline battery cells while power supply adapter is connected, otherwise they may explode!**
- ❑ **Hazardous voltages exist inside the instrument. Disconnect all test leads, remove the power supply cable and switch off the instrument before removing battery compartment cover.**
- ❑ **All normal safety precautions have to be taken in order to avoid risk of electric shock when working on electrical installations!**

 **Warnings related to measurement functions:**

Insulation resistance

- ❑ **Do not touch the test object during the measurement or before it is fully discharged! Risk of electric shock!**
- ❑ **Automatic discharge of capacitive object will take some time after the finished insulation resistance measurement. Actual voltage is displayed during discharging until voltage drops below 10 V. In no case you should disconnect test leads until tested object is completely discharged!**

Notes related to measurement functions:**General**

- ❑ If there is any irregular condition on input terminals then the selected measurement can't be performed.
- ❑ **Insulation resistance continuity** measurements shall be performed on de-energized objects, i.e. voltage between test terminals should be lower than 10 V!
- ❑ PASS / FAIL indication is enabled when limit is set to ON. Apply appropriate limit value for evaluation of measurement results.

Insulation resistance

- ❑ When measuring insulation resistance between installation conductors all loads must be disconnected and all switches closed!
- ❑ The instrument automatically discharge tested object after finished measurement.
- ❑ Click the TEST key twice for continuous measurement.
- ❑ It is recommended to use the GUARD connection when high insulation resistance (>10G Ω) is measured. You need optional 2.5 kV 3-wire test lead.
- ❑ The guard terminal is internal impedance (660 k Ω) protected.
- ❑ The DAR and PI diagnostic is automatically calculated during insulation measurements.

Continuity functions

- ❑ Parallel resistance paths and interfering currents in measured circuit will influence the test result!
- ❑ If necessary compensate test lead resistance before performing continuity measurement, see 5.2.3.
- ❑ Measurement of resistance of wire wound components like transformer or motor windings is possible only in continuous function due to great influence of the winding inductance.

2.2 Battery and charging

The instrument uses six AA size alkaline or rechargeable Ni-Cd or Ni-MH battery cells. Nominal operating time is declared for cells with nominal capacity of 2100 mAh. Battery condition is always present on the display when the instrument is turned on. In case the battery is weak, the instrument indicates this as shown in **Figure 2.1**. This indication appears for a few seconds and then the instrument turns itself off.



Figure 2.1: Discharged battery indication

The battery is charged whenever the power supply adapter is connected to the instrument. Internal circuit controls charging assuring maximum battery lifetime. The power supply socket polarity is shown in **Figure 2.2**.



Figure 2.2: Power supply socket polarity

The instrument automatically recognizes the connected power supply adapter and begins charging. See the **Figure 2.3**.

Symbols:

	Indication of battery charging
---	--------------------------------

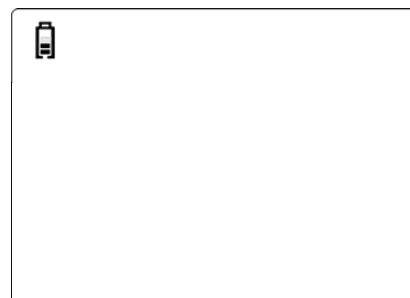



Figure 2.3: Charging indication

- ❑  **Before opening battery / fuse compartment cover, disconnect all accessories connected to the instrument and switch off the instrument.**
- ❑ Insert cells correctly, otherwise the instrument will not operate and the battery could be damaged.
- ❑ Remove all battery cells from the battery compartment if the instrument is not used for a long period of time.
- ❑ Do not charge alkaline battery cells!
- ❑ Take into account handling, maintenance and recycling requirements that are defined by related regulations and manufacturers of alkaline or rechargeable batteries!
- ❑ Use only power supply adapter delivered from the manufacturer or distributor of the test equipment to avoid possible fire or electric shock!

2.2.1 New battery cells or cells unused for a longer period

Unpredictable chemical processes can occur during charging of new battery cells or cells that were unused for a longer period (more than 3 months). Ni-MH and Ni-Cd battery cells are affected to capacity degradation (sometimes called as memory effect). As a result, the instrument operation time can be significantly reduced.

Recommended procedure for recovering battery cells:

Procedure	Notes
➤ Completely charge the battery.	<i>At least 14h with in-built charger.</i>
➤ Completely discharge the battery.	<i>Use the instrument for normal testing until the unit displays the "Bat" symbol on screen.</i>
➤ Repeat the charge / discharge cycle for at least twice .	<i>Four cycles are recommended.</i>

Complete discharge / charge cycle can be performed automatically for each cell using external intelligent battery charger.

Notes:

- ❑ The charger in the instrument is a pack cell charger. This means that the battery cells are connected in series during the charging. The battery cells have to be equivalent (same charge condition, same type and age).
- ❑ One different battery cell can cause an improper charging and incorrect discharging during normal usage of the entire battery pack (it results in heating of the battery pack, significantly decreased operation time, reversed polarity of defective cell,...).
- ❑ If no improvement is achieved after several charge / discharge cycles, then each battery cell should be checked (by comparing battery voltages, testing them in a cell charger, etc). It is very likely that only some of the battery cells are deteriorated.
- ❑ The effects described above should not be confused with the normal decrease of battery capacity over time. Battery also loses some capacity when it is repeatedly charged / discharged. Actual decreasing of capacity, versus number of charging cycles, depends on battery type. This information is provided in the technical specification from battery manufacturer.

2.2.2 Auto Power Off

The Instrument has the Auto Power Off function. If the instrument is Turn On and inactive for period of 15 minutes, it automatically Turn Off.

2.3 Standards applied

The MI 3121H Smartec 2,5 kV Insulation / Continuity instrument is manufactured and tested according to the following regulations, listed below.

Electromagnetic compatibility (EMC)

EN 61326	Electrical equipment for measurement, control and laboratory use – EMC requirements Class B (Hand held equipment used in controlled EM environments)
----------	---

Safety (LVD)

EN 61010 - 1	Safety requirements for electrical equipment for measurement, control, and laboratory use – Part 1: General requirements
EN 61010 - 031	Safety requirements for hand-held probe assemblies for electrical measurement and test

Functionality

EN 61557	Electrical safety in low voltage distribution systems up to 1000 V a.c. and 1500 V d.c. - Equipment for testing, measuring or monitoring of protective measures
	Part 1 General requirements
	Part 2 Insulation resistance
	Part 4 Resistance of earth connection and equipotential bonding
	Part 10 Combined measuring equipment

Note about EN and IEC standards:

Text of this manual contains references to European standards. All standards of EN 6xxxx (e.g. EN 61010) series are equivalent to IEC standards with the same number (e.g. IEC 61010) and differ only in amended parts required by European harmonization procedure.

3 Instrument description

3.1 Front panel



Figure 3.1: Front panel

Legend:

1	LCD	Custom display with backlight.
2	TEST	Starts / stops a measurement.
3	UP	Modifies selected parameter.
4	DOWN	
5	MEM	Store / recall / clear tests in memory of instrument.
6	Function selector	Select test function.
7	Backlight	Changes backlight level.
8	ON / OFF	Switches the instrument power on or off. <i>The instrument automatically turns off 15 minutes after the last key was pressed.</i>
9	CAL	Compensates test leads resistance in RLOW and CONT functions.
10	TAB	Selects the parameters in selected function.
11	PASS	Indicate acceptance of result.
12	FAIL	

3.2 Connector panel

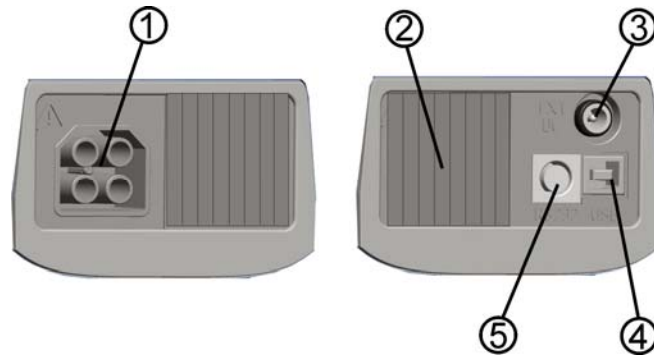

Figure 3.2: Connector panel

Legend:

1	Test connector	Measuring inputs / outputs, connection of measuring cables.
2	Protection cover	Protects from simultaneous access to test connector and power supply adapter socket / communication connectors.
3	Charger socket	Connection of power supply adapter.
4	USB connector	Communication with PC USB (1.1) port.
5	PS/2 connector	Communication with PC serial port.

Warnings!

- ❑ **Maximum allowed voltage between any test terminal and ground is 600 V!**
- ❑ **Maximum allowed voltage between test terminals is 600 V!**
- ❑ **Maximum short-term voltage of external power supply adapter is 14 V!**

3.3 Back panel



Figure 3.3: Back site

Legend:

1	Side belt
2	Battery compartment cover
3	Fixing screw for battery compartment cover
4	Back panel information label
5	Holder for inclined position of the instrument
6	Magnet for fixing instrument close to tested item

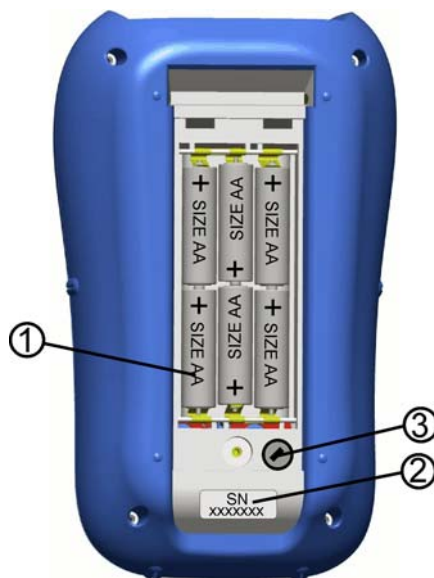

Figure 3.4: Battery compartment

Legend:

1	Battery cells	Size AA, alkaline or rechargeable NiMH / NiCd
2	Serial number label	
3	Fuse	M 0.315 A, 250 V

3.4 Display organization

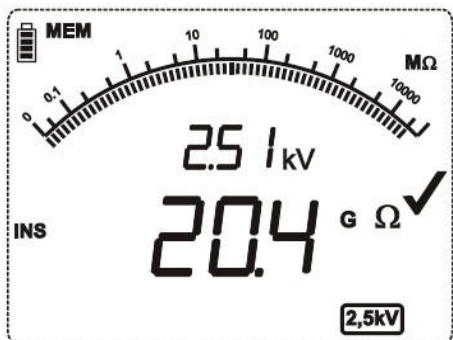

Figure 3.5: Typical display

INS CONT RLOW VOLT	Function field
> 18.8.8 kGMΩ ✓ V X	Result field
Analog scale with units: kΩ, GΩ, MΩ, V	Analog results display
100V 250V 500V 1kV 2,5kV	Test voltage selection field
⚡ ⚠ ⏳ 🔒 CAL LIM MEM RCL LOC OBJ PI DAR	Message field
18.8.8 Hz kV	Auxiliary monitor
🔋	Battery indication

3.4.1 Function field

The function field displays currently selected function.

INS	Selected function is Insulation resistance .
CONT	Selected function is 7 mA Continuous resistance measurement.
RLOW	Selected function is 200 mA Resistance to earth connection and equipotential bonding measurement.
VOLT	Selected function is Voltage / frequency measurement.

3.4.2 Result fields

Measuring results are displayed in numeric and analog representation with evaluation result in case the limits are selected.



Numeric readout of measurement result



Measurement result is inside pre-set limits (PASS).



Measurement result is out of pre-set limits (FAIL).



Analog presentation of measured result.

3.4.3 Message field

In the message field, different warnings and messages are displayed.



Warning! Read the User Manual with special care!



Warning! Dangerous voltage is applied to the test terminals.



Measurement is implemented.

CAL

Test leads resistance in CONTINUITY tests is compensated.

LIM

Indicates that limit value can be set.

MEM

Offers storing of measurement result.

RCL

Indicates that recall memory is active.

LOC

Indicates location number in installation structure.

OBJ

Indicates object number in installation structure.

PI

Indicates **Polarization Index** result in the Insulation function.

DAR

Indicates **Dielectric Absorption Ratio** result in the Insulation function.

3.4.4 Auxiliary monitor

The monitor shows additional result, test parameter or message.

3.4.5 Battery indication

In the menu line, the name of the selected function is displayed. Additional information about active cursor / TEST keys and battery condition are shown.



Battery capacity indication.



Low battery.
Battery is too weak to guarantee correct result. Replace or recharge the battery cells.



Recharging in progress (moving segments if power supply adapter is connected).

3.4.6 Other messages

HA_r

HW version of the instrument

SDF

Version of built in FW.

Err

Service intervention required.

LI_t

On

Locked high backlight intensity.

r₁

1st sub result in RLOW function.

r₂

2nd sub result in RLOW function.

FUS

Fuse F1 has blown or has not been inserted (CONTINUITY function)

rES

Setting of limit (Resistance value).

3.4.7 Backlight

With the **BACKLIGHT** key the backlight can be adjusted.

Click

Toggle backlight intensity level.

Pressed for 1 s

Locks-on high backlight. It keeps until power off or next click on the key BACKLIGHT.

3.5 Instrument set and accessories

3.5.1 Standard set

- ❑ Instrument MI 3121H
- ❑ Instruction manual
- ❑ Calibration certificate
- ❑ 2.5 kV test lead, 2 x 1.5 m
- ❑ Test probe, 2 pcs
- ❑ Crocodile clip, 2 pcs
- ❑ NiMH battery cell, type AA, 6 pcs
- ❑ Power supply adapter
- ❑ CD with instruction manual, and
*“Guide for testing and verification of
low voltage installations”* handbook
- ❑ Soft hand strap

3.5.2 Optional accessories

See the attached sheet for a list of optional accessories that are available on request from your distributor.

4 Instrument operation

4.1 Function selection

For selecting test function, the **FUNCTION SELECTOR** shall be used.

Keys:

FUNCTION SELECTOR (BACK / NEXT)	Select test / measurement function: <ul style="list-style-type: none"> □ <VOLT> Voltage and frequency and phase sequence. □ <INS> Insulation resistance measurement. □ <RLOW / CONT> Resistance to earth connection and equipotential bonding / continuous resistance measurement.
UP/DOWN	Selects sub-function in selected measurement function.
TAB	Selects the test parameter to be set or modified.
TEST	Runs selected test / measurement function.
MEM	Stores measured results / recalls stored results.
CAL	Compensation of test leads resistance.

Keys in **test parameter** field:

UP/DOWN	Changes the selected parameter.
TAB	Selects the next measuring parameter.
FUNCTION SELECTOR	Toggles between the main functions.
MEM	Stores measured results / recalls stored results.

General rule regarding enabling **parameters** for evaluation of measurement / test result:

Parameter	---	No limit values.
Value		Results will be marked as PASS or FAIL in accordance with selected limit.

See *Chapter 5* for more information about the operation of the instrument test functions.

4.2 Settings

The instrument offers additional functions by the following combinations of the keys during power on. Combinations are:

UP + ON	Opens settings menu.
TAB + ON	Resets the instrument to initial factory settings.

Different instrument options can be set in the settings menu.

Options are:

- Setting the instrument to initial values,
- Setting the date and time.



Figure 4.1: Options in Settings menu

Keys:

UP / DOWN	Selects appropriate option.
TEST	Enters selected option.
Function selector	Exits back to main function menu.

4.2.1 Initial settings

Selecting this option will allow the user to reset the instrument settings and measurement parameters and limits to the manufacturers standard values.

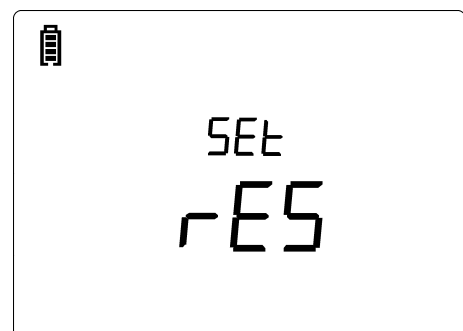

Figure 4.2: Initial settings display

Keys:

TEST	Restores default settings.
Function selector	Exits back to main function menu without changes.

Warning:

- Custom made settings will be lost when this option is used!
- If the batteries are removed for more than 1 minute, the custom made settings will be lost.

The default setup is listed below:

Instrument setting	Default value
Function	
Sub-function	Parameters / limit value
Insulated resistance	No limit, Utest = 500 V
Continuity	RLOW
RLOW	No limit
CONT	No limit

Note:

- Initial settings (reset of the instrument) can be recalled also if the TAB key is pressed while the instrument is switched on.

4.2.2 Date and time

Selecting this option will allow the user to set the date and time of the unit.

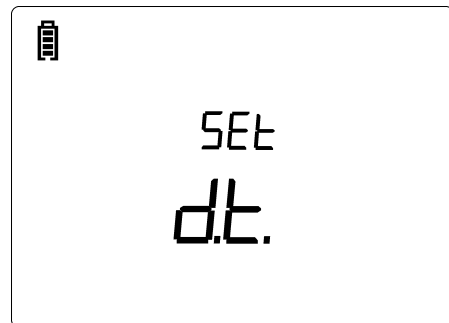

Figure 4.3: Setting date and time

Keys:

TAB	Selects the field to be changed.
UP / DOWN	Modifies selected field.
TEST	Confirms new setup and exits.
Function selector	Exits back to main function menu.

Indications:

d d 27	Set day.
drn 02	Set month.
d y 08	Set year.
t h 11	Set hour.
trn 35	Set minute.

Warning:

- If the batteries are removed for more than 1 minute, the set time will be lost.

5 Measurements

5.1 Insulation resistance

5.1.1 Insulation resistance measuring procedure

Insulation resistance measurement is performed in order to assure safety against electric shock through insulation. It is covered by the EN 61557-2 standard. Typical applications are:

- ❑ Insulation resistance between conductors of installation,
- ❑ Insulation resistance of non-conductive rooms (walls and floors),
- ❑ Insulation resistance of ground cables,
- ❑ Resistance of semi-conductive (antistatic) floors.

See chapter 4.1 *Function selection* for instructions on key functionality.

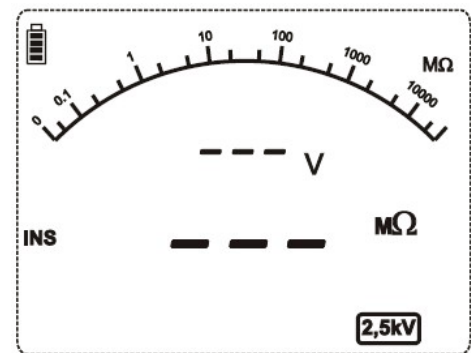

Figure 5.1: Insulation resistance

Test parameters for insulation resistance measurement

Uiso	Test voltage [100 V, 250 V, 500 V, 1000 V, 2.5 kV]
Limit	Minimum insulation resistance [OFF, 0.01 MΩ ÷ 200 MΩ]

Test circuits for insulation resistance

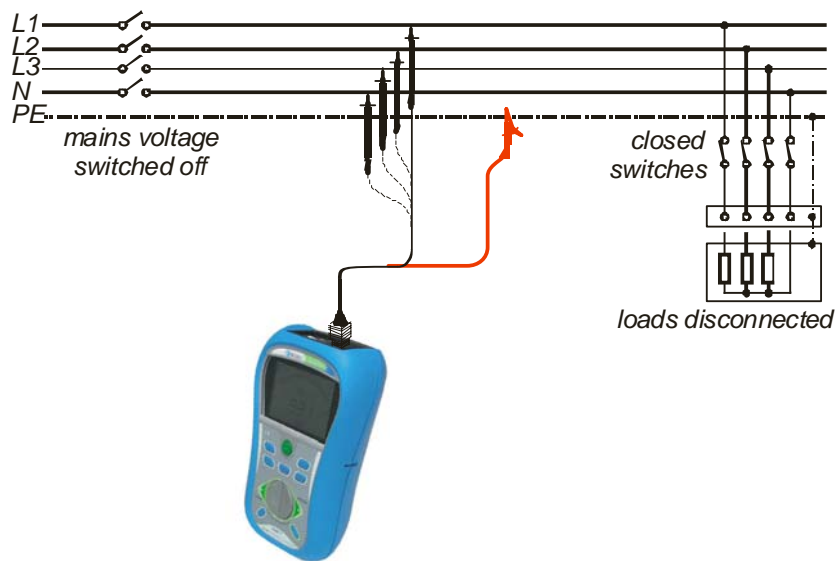

Figure 5.2: Connection of 2-wire test lead

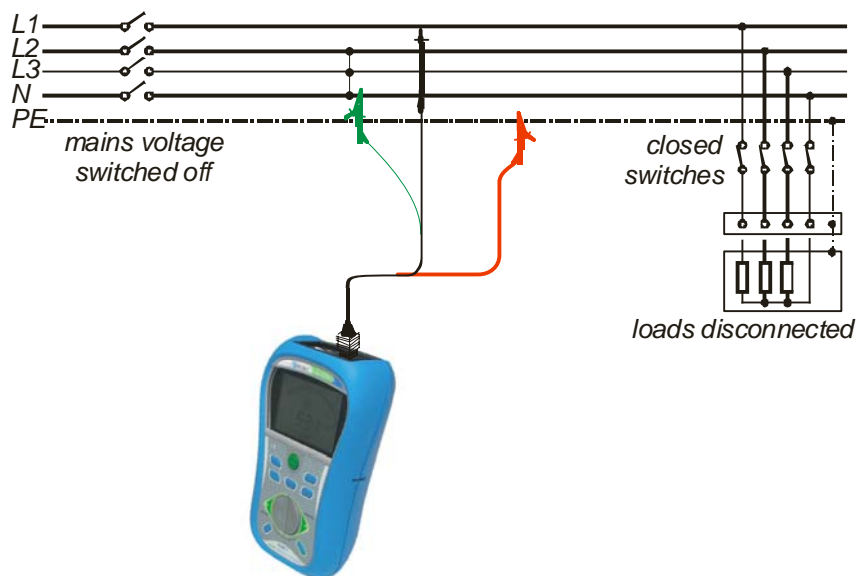

Figure 5.3: Connection of optional 3-wire test lead (A 1319)

Insulation resistance measuring procedure

- ❑ Select the **INS** function using the **BACK / NEXT** keys of function selector.
- ❑ Set the required **test voltage** (Press the TAB key then use arrows).
- ❑ Enable and set **limit** value (optional).
- ❑ **Disconnect** tested installation from mains supply (and discharge insulation as required).
- ❑ **Connect** test lead to the top of the instrument and to the item to be tested (see **Figure 5.2** and **Figure 5.3**).
- ❑ Press the **TEST** key to perform the measurement (double click for continuous measurement and later press to stop the measurement).
- ❑ After the measurement is finished wait until tested item is fully discharged.
- ❑ **Store** the result by pressing the MEM key (optional).

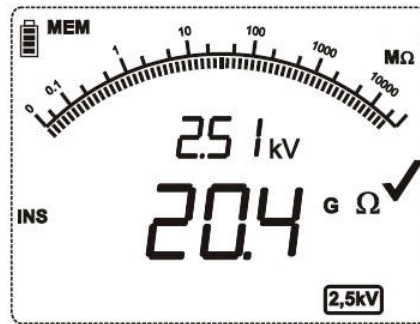

Figure 5.4: Example of insulation resistance measurement result

Displayed results:

- Insulation resistance – value,
- Insulation resistance – analog presentation,
- Test voltage – actual value.
- Test voltage – nominal value.

5.1.2 The DAR and PI diagnostic

The **DAR** and **PI** diagnostic is automatically calculated during insulation measurements.

DAR is ratio of Insulation Resistance values measured after 15s and after 1 minute. The DC test voltage is present during the whole period of the measurement.

When internal timer reaches 15 seconds, $R_{ISO}(15s)$ is stored into the internal memory (short beep is generated).

When internal timer reaches 1 minute, $R_{ISO}(1min)$ is stored into the internal memory (short beep is generated). The **DAR** factor is calculated and stored into the internal memory. The **DAR** icon becomes also active to signalize during measurement, that **DAR** factor has been calculated.

$$DAR = \frac{R_{iso}(1min)}{R_{iso}(15s)}$$

PI is the ratio of Insulation Resistance values measured after 1 minute and after 10 minutes. The DC test voltage is present during the whole period of the measurement

When internal timer reaches 10 minute, $R_{ISO}(10min)$ is stored into the internal memory (short beep is generated). The **PI** factor is calculated and stored into the internal memory. The **PI** icon becomes also active to signalize during measurement, that **PI** factor has been calculated.

$$PI = \frac{R_{iso}(10min)}{R_{iso}(1min)}$$

It is possible to switch between **DAR**, **PI** and insulation results **during** measurement by pressing the **TAB** key. See the **Figure 5.5** and **Figure 5.6**.

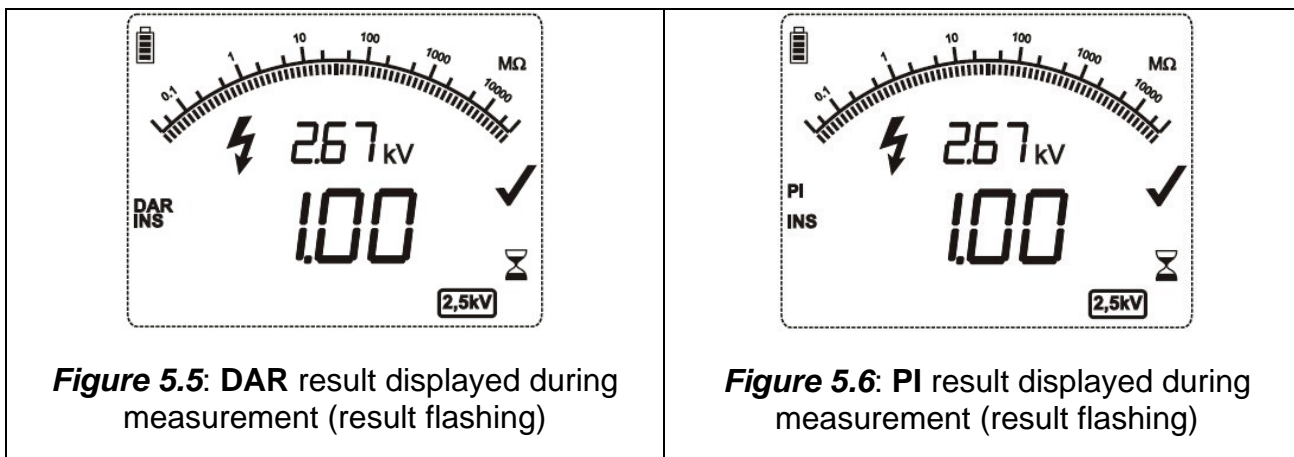

After measurement is finished it is possible to switch between **DAR**, **PI**, also **R60** and insulation results. **R60** is the resistance value measured 1minute (60 seconds) after start of the measurement.

Simply keep pressing (few seconds) the TAB key to enter to the sub results menu. Here you can list sub results (**DAR**, **PI**, and **R60**) with normal pressing on the TAB key. Automatically turn back from sub result menu is occurred, after all sub results are displayed once. See the **Figure 5.7**, **Figure 5.8** and **Figure 5.9**.

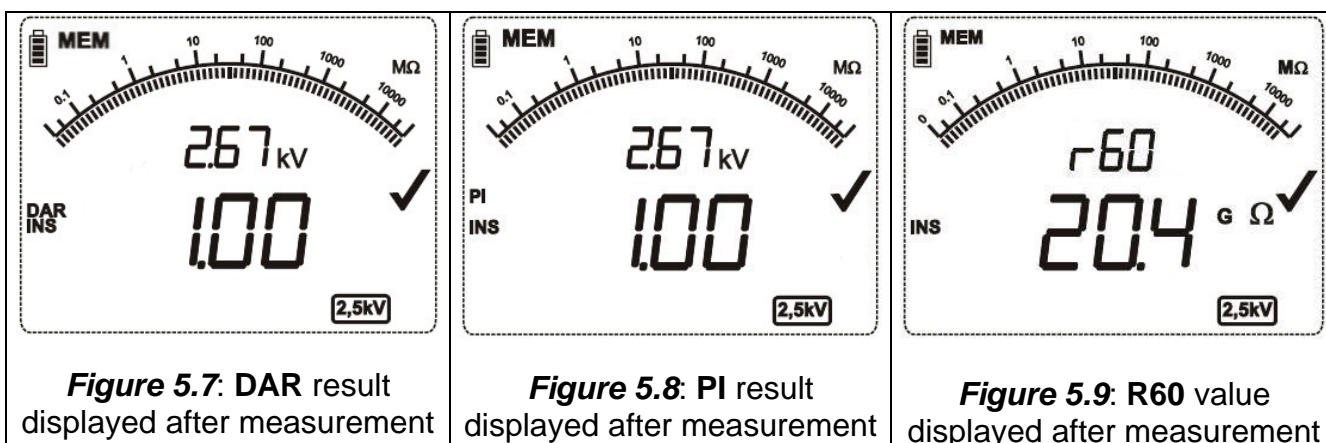

For additional information regarding **PI** and **DAR** diagnostic, please refer to Metrel's handbook **Modern Insulation Testing**.

5.1.3 Guard terminal

The purpose of the GUARD terminal is to lead away potential leakage currents (e.g. surface currents), which are not a result of the measured insulation material itself but of the surface contamination and moisture. This current interferes with the measurement i.e. the Insulation Resistance result is influenced by this current. The GUARD terminal is internally connected to the same potential as the negative test terminal (black one). The GUARD test alligator should be connected to measured object so as to collect most of the unwanted leakage current, see the figure below.

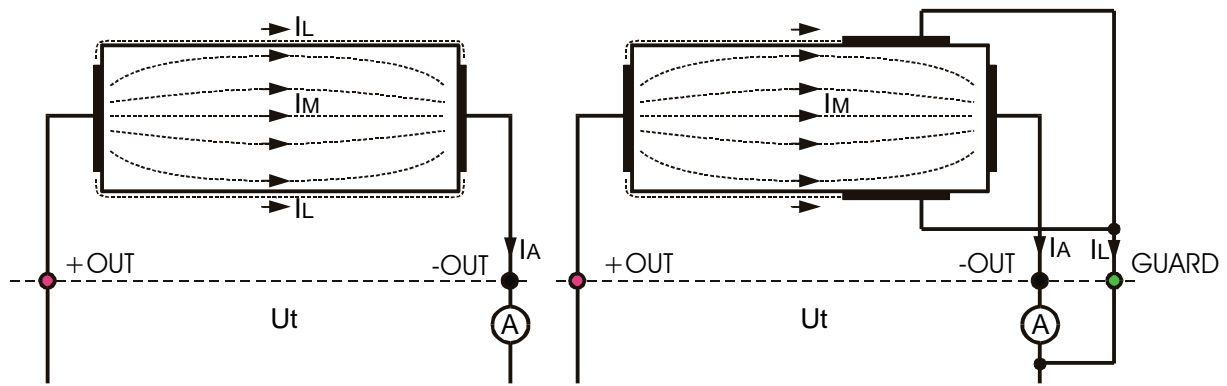

Figure 5.10: Connection of GUARD terminal to measured object

where:

U_t Test voltage

I_L Leakage current (resulted by surface dirt and moisture)

I_M Material current (resulted by material conditions)

I_A A-meter current

Result without using GUARD terminal: $R_{INS} = U_t / I_A = U_t / (I_M + I_L)$...incorrect result.

Result using GUARD terminal: $R_{INS} = U_t / I_A = U_t / I_M$ correct result.

It is recommended to use the GUARD connection when high insulation resistance (>10G Ω) is measured. You need optional 2.5 kV 3-wire test lead (**Figure 5.3**).

The guard terminal is internal impedance (660 k Ω) protected.

5.2 Resistance of earth connection and equipotential bonding

The resistance measurement is performed in order to assure that the protective measures against electric shock through earth bond connections are effective. Two sub-functions are available:

- RLOW - Earth bond resistance measurement according to EN 61557-4 (200 mA),
- CONT - Continuous resistance measurement performed with 7 mA.

See chapter 4.1 *Function selection* for instructions on key functionality.

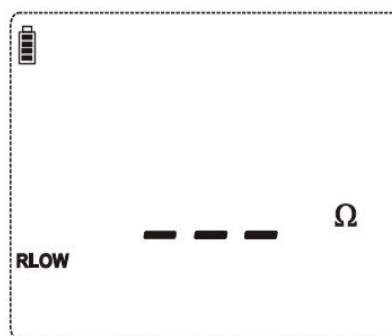

Figure 5.11: 200 mA RLOW function example

Test parameters for resistance measurement

Test	Resistance measurement sub-function [RLOW, CONT]
Limit	Maximum resistance [OFF, 0.1 Ω ÷ 20.0 Ω]

5.2.1 RLOW, 200 mA resistance measurement

The resistance measurement is performed with automatic polarity reversal of the test voltage.

Test circuit for RLOW measurement

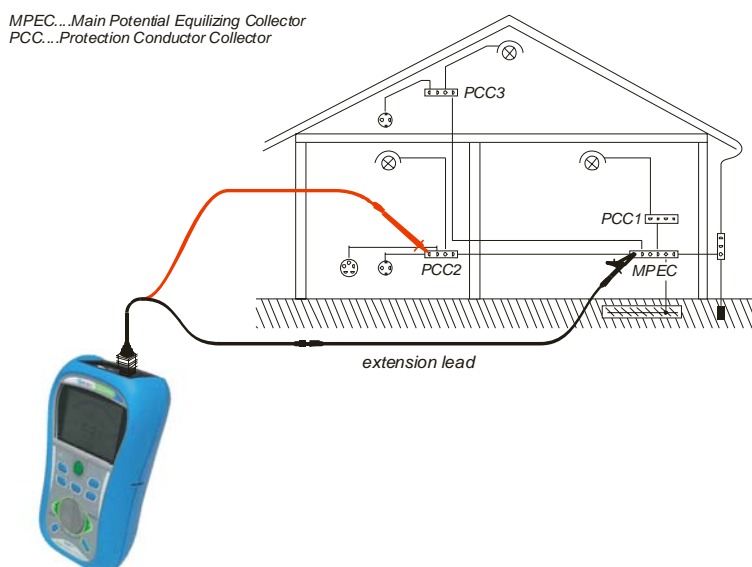

Figure 5.12: Connection of 2-wire test lead plus optional extension lead

Resistance to earth connection and equipotential bonding measurement procedure

- ❑ Select continuity function (**RLOW** or **CONT**) using the **BACK** / **NEXT** keys of function selector.
- ❑ Set sub-function to **RLOW**.
- ❑ Enable and set **limit** (optional).
- ❑ **Connect** test lead to the top of the instrument.
- ❑ **Compensate** the test leads resistance (if necessary, see *section 5.2.3*).
- ❑ **Disconnect** from mains supply and discharge installation to be tested.
- ❑ **Connect** the test leads to the appropriate PE wiring (see *Figure 5.12*).
- ❑ Press the **TEST** key to perform the measurement.
- ❑ After the measurement is finished **store** the result by pressing the MEM button (optional).

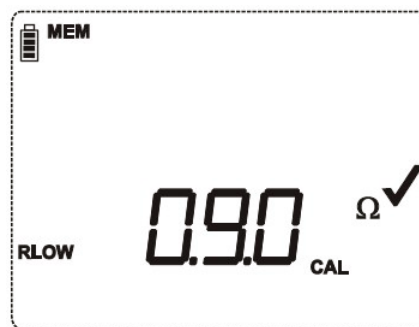

Figure 5.13: Example of RLOW result

Displayed result:

Main RLOW resistance.

Sub results checking

- ❑ Press the key TAB for a few seconds.
- ❑ The instrument will display sub result r1.
- ❑ Click the key TAB.
- ❑ The instrument will display sub result r2.
- ❑ Next click on the key TAB will return the instrument to display main result.

5.2.2 Continuous 7 mA resistance measurement CONT

In general, this function serves as standard Ω -meter with a low testing current. The measurement is performed continuously without polarity reversal. The function can also be applied for testing continuity of inductive components.

Test circuit for CONT resistance measurement

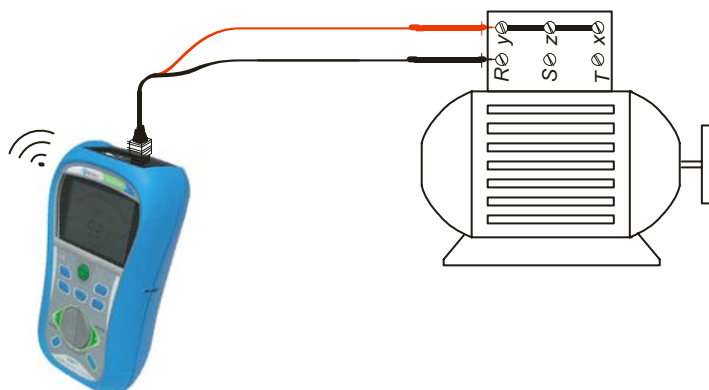

Figure 5.14: 2-wire test lead application

Continuous resistance measurement procedure

- ❑ Select continuity function **RLOW** or **CONT** using the **BACK** / **NEXT** keys of function selector.
- ❑ Set sub-function **CONT**.
- ❑ Enable and set the **limit** (optional).
- ❑ **Connect** test lead to the instrument.
- ❑ **Compensate** test leads resistance (if necessary, see section 5.2.3).
- ❑ **Disconnect** from mains supply and discharge the object to be tested.
- ❑ **Connect** test leads to the tested object (see **Figure 5.14**).
- ❑ Press the **TEST** key to begin performing a continuous measurement.
- ❑ Press the **TEST** key to stop measurement.
- ❑ After the measurement is finished, **store** the result (optional).

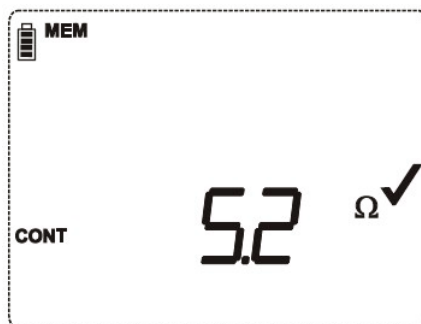

Figure 5.15: Example of continuous resistance measurement

Displayed result:
Resistance.

Note:

- ❑ Continuous buzzer sound indicates that measured resistance is less than 2 Ω.

5.2.3 Compensation of test leads resistance

This chapter describes how to compensate for test leads resistance in both continuity functions (RLOW and CONT). Compensation is required to eliminate the influence of test leads resistance and the internal resistances of the instrument on the measured resistance. The lead compensation is therefore a very important feature to obtain correct result. Once compensation has been performed, the compensation symbol (**CAL**) appears on the screen.

Each of RLOW and CONT has each own compensation.

Circuits for compensating the resistance of test leads

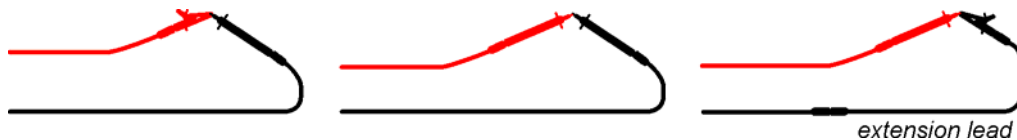

Figure 5.16: Shorted test leads

Compensation of test leads resistance procedure

- ❑ Select the any continuity function using the function switch.
- ❑ **Connect** test lead to the top of the instrument and short the test leads together (see **Figure 5.16**).
- ❑ Press **TEST** to perform resistance measurement.
- ❑ Press the **CAL** key to compensate leads resistance.

Note:

- ❑ The limit value for lead compensation is 5 Ω .

5.3 Voltage and frequency

In the **VOLT** menu the measured voltage and frequency are displayed.

See 4.1 *Function selection* for instructions on key functionality,

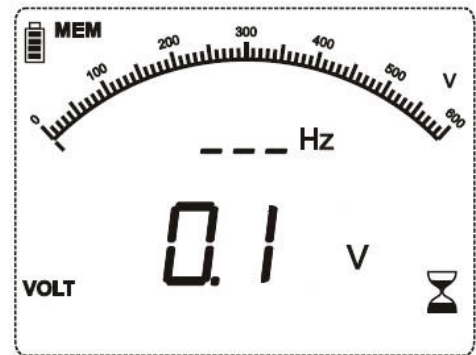

Figure 5.17: Voltage and frequency display

Circuits for voltage measurement

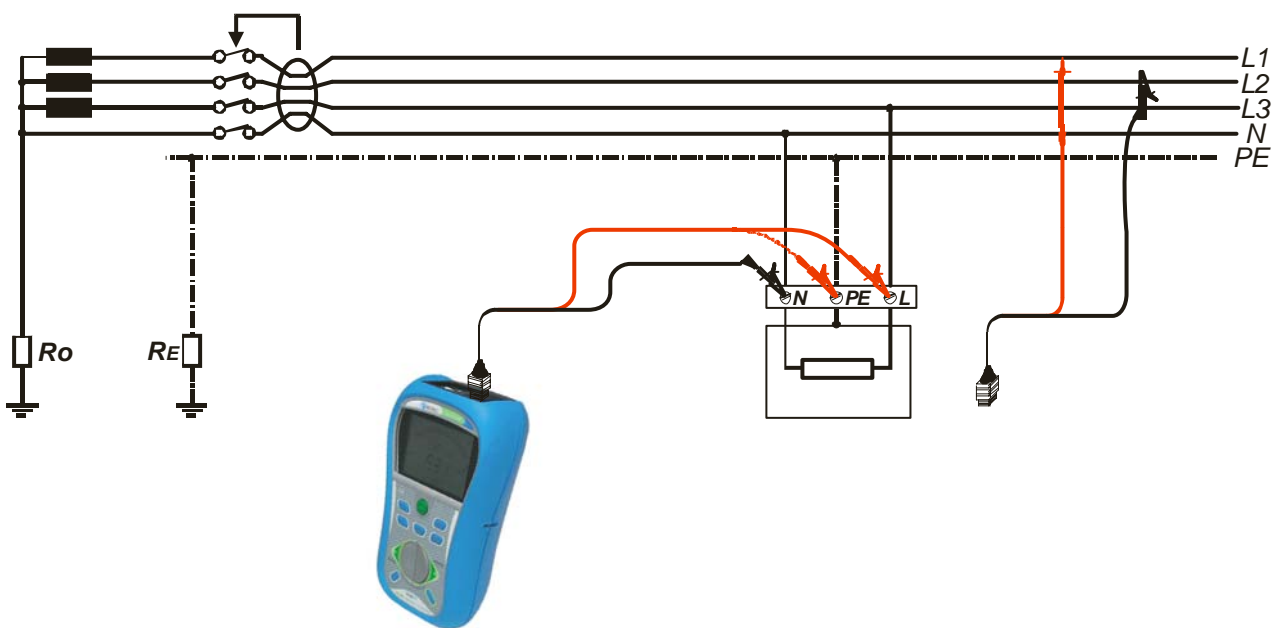

Figure 5.18: Connection of 2-wire test lead

Voltage measurement procedure

- ❑ Select the **VOLT** function.
- ❑ **Connect** test lead to the instrument.
- ❑ **Connect** test leads to the tested object (see **Figure 5.18**).
- ❑ **Store** voltage measurement result (optional).

Measurement starts immediately after selection of **VOLT** function.

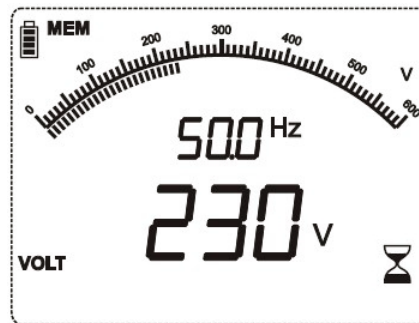

Figure 5.19: Example of voltage measurement

Displayed results:

- Voltage between test terminals – value,
- Voltage between test terminals – analog presentation,
- Frequency.

6 Data handling

6.1 Memory organization

Measurement results together with all relevant parameters can be stored in the instrument's memory.

6.2 Data structure

The instrument's memory place is divided into 2 levels each containing 199 locations. The number of measurements that can be stored into one location is not limited.

The **data structure** describes the identity of the measurement (which object, location).

This organization helps to handle with data in a simple and effective manner.

The main advantages of this system are:

- ❑ Test results can be organized and grouped in a structured manner that reflects the structure of typical electrical installations.
- ❑ Browsing through structures and results is simple.
- ❑ Test reports can be created with no or little modifications after downloading results to a PC.



Figure 6.1: Save / recall test menu

Fields in memory organization:

	<p>Location number is 6. Number of stored results at currently selected location / object (6/16) is 11.</p>
	<p>Object number is 16. Number of stored results at currently selected location / object (6/16) is 11.</p>

6.3 Storing test results

After the completion of a test, the results and parameters are ready for storing (**MEM** is displayed with result). By pressing the **MEM** key, the user can store the results.

Keys in save test menu - data structure field:

TAB	Selects the location element (Object / Location)
UP / DOWN	Selects number of selected location element (1 to 199)
MEM	Saves test results to the selected location and returns to the measuring menu.
Function selector / TEST	Exits back to main function menu.

Notes:

- The instrument offers storing the result to the last selected location by default.
- Press the **MEM** key twice to store the measurement to the same location.

6.4 Recalling test results

Press shortly the **MEM** key in a main function menu when there is no result available for storing (no **MEM** indication).

Keys in recall memory menu (data structure selected):

TAB	Selects the location element (Object / Location).
UP / DOWN	Selects number of selected location element.
MEM	Opens last stored result in selected location.
Function selector / TEST	Exits back to main function menu.

Keys in recall memory menu (measurements selected):

UP / DOWN	Displays next / previous stored measurement.
MEM	Returns to main MEM menu.
Function selector / TEST	Exits back to main function menu.

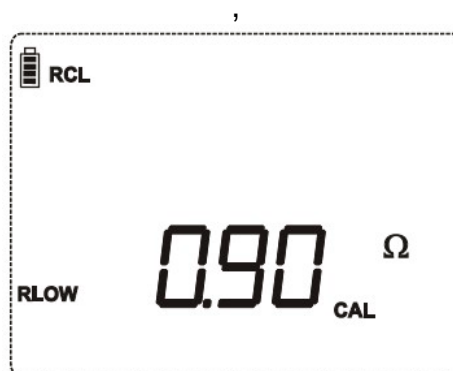

Figure 6.2: Example of recalled measurement result

6.5 Clear / recall options

Press the MEM key in a main function menu for few seconds to activate possibility for clearing or recalling results.

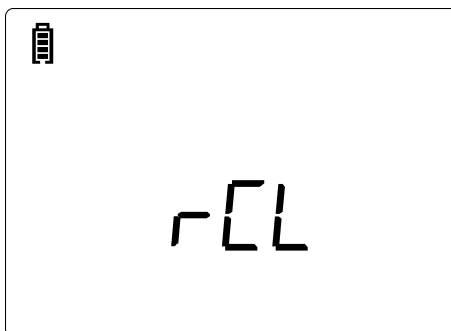

Figure 6.3: Entering menu for recall / clear options on stored results

Keys in recall / clear memory menu:

UP	Opens menu to clear result at currently selected location.
DOWN	Opens menu to clear all results.
TEST	Confirms selected clear option (CLR All, see 6.5.1; CLR, see 6.5.2) Opens last selected location to recall the results or change location, see 6.4.
Function selector / MEM / TAB	Exit back to main function menu.

6.5.1 Clearing complete memory content

After selection of **CLEAR ALL**, the instrument will display the following:



Initial display to clear all memory



Required confirmation to clear all

Figure 6.4: Clear all memory

Keys in clear all memory menu:

TEST	Confirms clearing of complete memory content.
Function selector / TAB	Exits back to main function menu without changes.

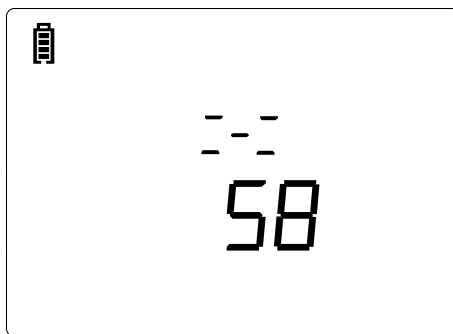

Figure 6.5: Clearing memory in progress

6.5.2 Clearing individual results at selected location

After selection of **CLEAR** result, the instrument will display the following:

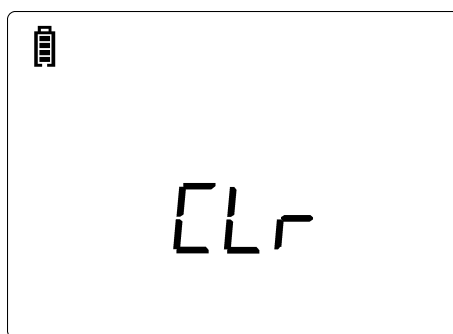

Figure 6.6: Clear measurements menu

Keys in clearing individual results menu (data structure field selected):

TAB	Selects the location element (Object / Location).
UP / DOWN	Selects number of selected location element.
TEST	Opens last result at selected location
	<p>UP / DOWN Rotate through stored results to select one to clear</p> <p>TEST Clears current recalled result and recalls the next one.</p>
Function selector / MEM	Exits back to main function menu without changes.

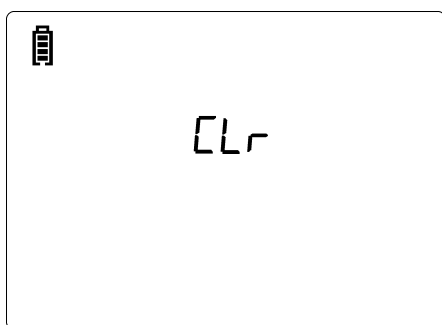

Figure 6.7: Clearing in progress



Figure 6.8: Display after finished clear

6.6 Communication

Stored results can be transferred to a PC. A special communication program on the PC automatically identifies the instrument and enables data transfer between the instrument and the PC.

There are two communication interfaces available on the instrument: USB or RS 232.

The instrument automatically selects the communication mode according to detected interface. USB interface has priority.

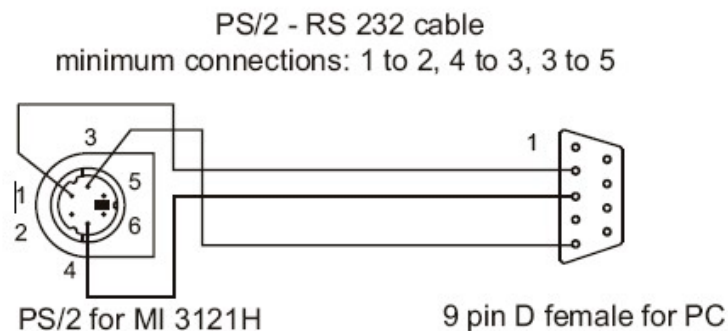

Figure 6.9: Interface connection for data transfer over PC COM port

How to transfer stored data:

- ❑ RS 232 communication: connect a PC COM port to the instrument PS/2 connector using the PS/2 - RS232 serial communication cable;
- ❑ USB communication: connect a PC USB port to the instrument USB connector using the USB interface cable.
- ❑ Switch **on** the PC and the instrument.
- ❑ **Run** the *EuroLink PRO* program.
- ❑ The PC and the instrument will automatically recognize each other.
- ❑ The instrument is prepared to download data to the PC.

The program *EuroLink PRO* is a PC software running on Windows 95/98, Windows NT, Windows 2000, Windows XP, Windows Vista, Windows 7. Read the file README.TXT on CD for instructions about installing and running the program.

Note:

- ❑ USB drivers should be installed on PC before using the USB interface. Refer to USB installation instructions available on installation CD.

7 Maintenance

Unauthorized persons are not allowed to open the Smartec 2,5 kV Insulation / Continuity instrument. There are no user replaceable components inside the instrument, except the fuse and battery under rear cover.

7.1 Fuse replacement

There is a fuse under back cover of the Smartec 2,5 kV Insulation / Continuity instrument.

- F1
M 0.315 A / 250 V, 20×5 mm
This fuse protects internal circuitry for continuity functions if test probes are connected to the mains supply voltage by mistake during measurement.

Warnings:

-  **Disconnect all measuring accessory and switch off the instrument before opening battery / fuse compartment cover, hazardous voltage inside!**
- Replace blown fuse with original type only, otherwise the instrument may be damaged and/or operator's safety impaired!

Position of fuses can be seen in **Figure 3.4** in chapter **3.3 Back panel**.

7.2 Cleaning

No special maintenance is required for the housing. To clean the surface of the instrument use a soft cloth slightly moistened with soapy water or alcohol. Then leave the instrument to dry totally before use.

Warnings:

- Do not use liquids based on petrol or hydrocarbons!
- Do not spill cleaning liquid over the instrument!

7.3 Periodic calibration

It is essential that the test instrument is regularly calibrated in order that the technical specification listed in this manual is guaranteed. We recommend an annual calibration. Only an authorized technical person can do the calibration. Please contact your dealer for further information.

7.4 Service

For repairs under warranty, or at any other time, please contact your distributor.

8 Technical specifications

8.1 Insulation resistance

Insulation resistance (nominal voltages 100 V_{DC} and 250 V_{DC})

Measuring range according to EN61557 is 0.15 M Ω ÷ 999.9 M Ω .

Measuring range (M Ω)	Resolution (M Ω)	Accuracy
0.00 ÷ 19.99	0.01	±(5 % of reading + 3 digits)
20.0 ÷ 199.9	0.1	±(10 % of reading)
200 ÷ 999	1	±(20 % of reading)

Insulation resistance (nominal voltages 500 V_{DC}, 1000 V_{DC} and 2500 V_{DC})

Measuring range according to EN61557 is 0.15 M Ω ÷ 100 G Ω .

Measuring range (Ω)	Resolution (M Ω)	Accuracy
0.00M ÷ 19.99M	0.01	±(5 % of reading + 3 digits)
20.0M ÷ 199.9M	0.1	±(5 % of reading)
200M ÷ 999M	1	
1.00G ÷ 4.99G	10	±(10 % of reading)
5.00G ÷ 19.99G	10	±(20 % of reading)
20.0G ÷ 99.9G	100	±(20 % of reading)

Dielectric absorption ratio DAR

Display range DAR	Resolution	Accuracy
0.01 ÷ 9.99	0.01	±(5% of reading + 2digits)
10.0 ÷ 100.0	0.1	±(5% of reading)

Polarization index PI

Display range PI	Resolution	Accuracy
0.01 ÷ 9.99	0.01	±(5% of reading + 2digits)
10.0 ÷ 100.0	0.1	±(5% of reading)

Voltage

Measuring range (V)	Resolution (V)	Accuracy
0 ÷ 1999	1	±(3 % of reading + 3 digits)
2.00k ÷ 3.00k	10	±(3 % of reading)

Nominal voltages 100 V_{DC}, 250 V_{DC}, 500 V_{DC}, 1000 V_{DC}, 2500 V_{DC}

Open circuit voltage -0 % / +20 % of nominal voltage

Measuring current..... min. 1 mA at R_N=U_N×1 k Ω /V

Short circuit current..... max. 3 mA

The number of possible tests..... > 1200, with a fully charged battery

Auto discharge after test.

Specified accuracy is valid up to 100 M Ω if relative humidity is move over 85 %.

In case the instrument gets moistened, the results could be impaired. In such case, it is recommended to dry the instrument and accessories for at least 24 hours.

The error in operating conditions could be at most the error for reference conditions (specified in the manual for each function) ±5 % of measured value.

8.2 Continuity

8.2.1 Resistance RLOW

Measuring range according to EN61557 is $0.16 \Omega \div 1999 \Omega$.

Measuring range R (Ω)	Resolution (Ω)	Accuracy
0.00 \div 19.99	0.01	$\pm(3 \%$ of reading + 3 digits)
20.0 \div 199.9	0.1	$\pm(5 \%$ of reading)
200 \div 1999	1	$\pm(10 \%$ of reading)

Open-circuit voltage $6.5 V_{DC} \div 9 V_{DC}$

Measuring current min. 200 mA into load resistance of 2Ω

Test lead compensation up to 5Ω

The number of possible tests > 2000, with a fully charged battery

Automatic polarity reversal of the test voltage.

8.2.2 Resistance CONT

Measuring range (Ω)	Resolution (Ω)	Accuracy
0.0 \div 19.9	0.1	$\pm(5 \%$ of reading + 3 digits)
20 \div 1999	1	$\pm(10 \%$ of reading)

Open-circuit voltage $6.5 V_{DC} \div 9 V_{DC}$

Short-circuit current max. 8.5 mA

Test lead compensation up to 5Ω

8.3 Voltage, frequency

8.3.1 Voltage

Measuring range (V)	Resolution (V)	Accuracy
0.0 \div 99.9	0.1	$\pm(3 \%$ of reading + 3 digits)
100 \div 550	1	

Result type True r.m.s. (trms)

Nominal frequency range 0 Hz, 15 Hz \div 500 Hz

8.3.2 Frequency

Measuring range (Hz)	Resolution (Hz)	Accuracy
0.00 \div 19.99	0.01	$\pm(0.2 \%$ of reading + 1 digit)
20.0 \div 199.9	0.1	
200 \div 500	1	

Nominal voltage range 10 V \div 550 V

8.4 General data

Power supply voltage.....	9 V _{DC} (6×1.5 V battery or accu, size AA)
Operation.....	typical 13 h
Charger socket input voltage	12 V ± 10 %
Charger socket input current.....	400 mA max
Battery charging current.....	250 mA (internally regulated)
Overvoltage category.....	600 V CAT III, 300 V CAT IV
Protection classification	double insulation
Pollution degree.....	2
Protection degree	IP 40

Display custom liquid crystal display with backlight

Dimensions (w × h × d) 14 cm × 8 cm × 23 cm
Weight 0.85 kg, without battery cells

Reference conditions

Reference temperature range..... 10 °C ÷ 30 °C
Reference humidity range..... 40 %RH ÷ 70 %RH

Operation conditions

Working temperature range 0°C ÷ 40 °C
Maximum relative humidity 95 %RH (0 °C ÷ 40 °C), non-condensing

Storage conditions

Temperature range..... -20 °C ÷ +70 °C
Maximum relative humidity 90 %RH (-10 °C ÷ +40 °C)
80 %RH (40 °C ÷ 60 °C)

Maximum operation voltage..... 600 V a.c.

Communication transfer speed

RS 232..... 115200 baud
USB 256000 baud

The error in operating conditions could be at most the error for reference conditions (specified in the manual for each function) +1 % of measured value + 1 digit, unless otherwise specified in the manual for particular function.

9 Appendix A - Accessories for specific measurements

The table below presents standard and optional accessories required for specific measurement. The accessories marked as optional may also be standard ones in some sets. Please see attached list of standard accessories for your set or contact your distributor for further information.

Function	Suitable accessories (Optional with ordering code A....)
Insulation resistance INS	<ul style="list-style-type: none"> <input type="checkbox"/> 2.5 kV test lead, 2 x 1.5 m <input type="checkbox"/> 2.5 kV test lead, 3 x 1.5 m (A 1319)
Continuity, 200 mA RLOW	<ul style="list-style-type: none"> <input type="checkbox"/> 2.5 kV test lead, 2 x 1.5 m <input type="checkbox"/> Test lead, black, 4 m (A 1154)
Continuity, 7 mA CONT	<ul style="list-style-type: none"> <input type="checkbox"/> 2.5 kV test lead, 2 x 1.5 m <input type="checkbox"/> Test lead, black, 4 m (A 1154)
Voltage, frequency	<ul style="list-style-type: none"> <input type="checkbox"/> 2.5 kV test lead, 2 x 1.5 m

